

APLISENS[®]

USER'S MANUAL

DIFFERENTIAL PRESSURE TRANSMITTER **AS-dP**

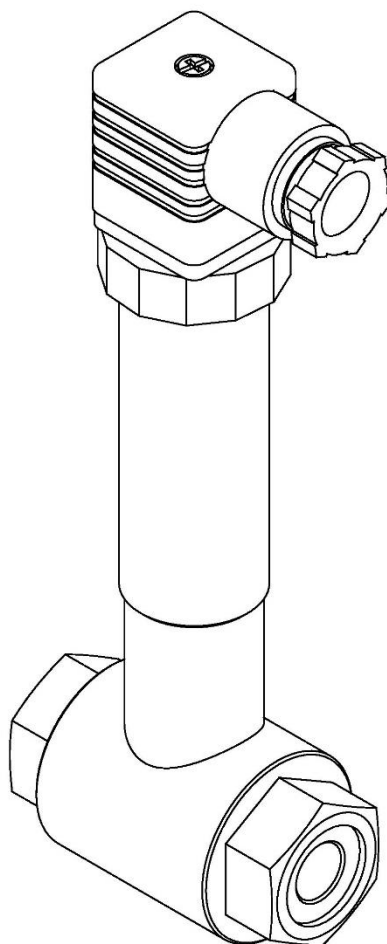

PRODUCT CODE – see: → 5.2. Transmitter identification

The QR code or ID number identifies the transmitter and provides quick access to the following documentation on the manufacturer’s website: user’s manual and declarations of conformity.

AS-dP

ID:0048 0001 0000 0000 0000 0000 0001 90

<https://www.aplisens.pl/ID/0048000100000000000000000000000190>



Symbols used

Symbol	Description
	Warning to proceed strictly in accordance with the information contained in the documentation in order to ensure the safety and full functionality of the device.
	Information particularly useful during installation and operation of the device.
	Information on disposal of used equipment.

BASIC REQUIREMENTS AND SAFE USE



The manufacturer will not be liable for damage resulting from incorrect installation, failure to maintain a suitable technical condition of the device or use of the device other than for its intended purpose.

Installation should be carried out by qualified staff having the required authorizations to install electrical and I&C equipment. The installer is responsible for performing the installation in accordance with manual as well as with the electromagnetic compatibility and safety regulations and standards applicable to the type of installation.

In systems with I&C equipment, in case of leakage, there is a danger to staff due to the medium under pressure. All safety and protection requirements must be observed during installation, operation and inspections.

If a malfunction occurs, the device should be disconnected and handed over to the manufacturer for repair.



In order to minimize the risk of malfunction and associated risks to staff, the device is not to be installed or used in particularly unfavourable conditions, where the following hazards occur:

- possible mechanical impacts, excessive shocks and vibration;
- excessive temperature fluctuation;
- water vapour condensation, dusting, icing.

Changes made to the manufacturing of products may be introduced before the paper version of the manual is updated. The up-to-date manuals are available on the manufacturer’s website: www.aplisens.com.

TABLE OF CONTENTS

1. INTRODUCTION	4
2. SAFETY	4
3. TRANSPORT AND STORAGE	4
3.1. Delivery check	4
3.2. Transport	4
3.3. Storage and use	4
4. GUARANTEE	4
5. IDENTIFICATION	4
5.1. Manufacturer address	4
5.2. Transmitter identification	5
5.3. CE mark, declaration of conformity	5
6. INSTALLATION AND CONNECTION	5
6.1. General recommendation	5
6.2. Connection with PD connector	6
6.3. Earthing	6
7. POWER SUPPLY	6
8. OPERATION	6
8.1. Setting of measurement range width and zero point	7
9. MAINTENANCE	7
9.1. Periodic inspections	7
9.2. Cleaning, washing	7
9.2.1. Diaphragm cleaning	7
9.3. Repair	7
9.4. Returns	7
10. SCRAPPING, DISPOSAL	7
11. HISTORY OF REVISIONS	7

1. INTRODUCTION

The AS-dP differential pressure transmitters are used for level measurement in closed tanks, as well as for differential pressure measurement on back pressure elements such as filters, orifices and wherever the static pressure is not high. Typical applications include: heat exchanger stations, district heating networks. The transmitters meet the requirements of EU directives in accordance with the Declaration of Conformity.

2. SAFETY



- The installation and start-up of the device and any activities related to operation shall be carried out after thorough examination of the contents of user's manual and the instructions related thereto.
- Installation and maintenance should be carried out by qualified staff having the required authorizations to install electrical and measuring devices.
- The device shall be used according to its intended purpose in line with the permissible parameters specified on the nameplate (→ 5.2. Transmitter identification).
- The protection elements used by the manufacturer to ensure transmitter safety may be less effective if the device is operated in a manner not consistent with its intended purpose.
- Before installing or disassembling the device, it is absolutely necessary to disconnect it from the power source.
- No repairs or alterations to the transmitter electronic system are permitted. Assessment of damages and possible repair may only be performed by the manufacturer or authorized representative.
- Do not use instruments if damaged. In case of malfunction, the device must be put out of operation.

3. TRANSPORT AND STORAGE

3.1. Delivery check

After receiving the delivery, please refer to the general terms and conditions of contracts available on the manufacturer's website: https://aplisens.com/ogolne_warunki_umow.html

3.2. Transport

Transport of transmitters shall be carried out with the use of covered means of transport, in original packages with diaphragm provided with protection. The packaging shall be protected against movement and direct impact of atmospheric factors.

3.3. Storage and use

Transmitters shall be stored in a factory packaging, in a room without vapours and aggressive substances, protected against mechanical impact.

Allowable storage and use temperature range

- AS-dP -25 ... 80°C (-13 ... 176°F);

4. GUARANTEE

General terms and conditions of guarantee are available on the manufacturer's website: https://aplisens.com/ogolne_warunki_gwarancji.html

5. IDENTIFICATION









5.1. Manufacturer address

APLISENS S.A.
03-192 Warsaw
Morelowa 7 St.
Poland

5.2. Transmitter identification

Depending on the version of the transmitter, the nameplates may differ in the amount of information and parameters.

Table 1. Symbols appearing on the transmitter nameplate

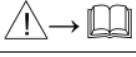
	Logo and name of manufacturer
	CE mark
03-192 WARSZAWA Morelowa 7 Poland tel.: +48 22 814 07 77	Manufacturer's address
	QR code
TYPE:	Transmitter, electrical and process connection type
ID	Transmitter model ID
# S/N	Transmitter serial number
	Measuring range
	Supply voltage values
	Output signal
	Permissible range of ambient temperature
	Permissible static Pressure
IP	IP protection rating
Year of production	Year of production
	Note about the obligation to read the manual
//The lower part of the nameplate//	Special version

5.3. CE mark, declaration of conformity

The device has been designed to meet the highest safety standards, has been tested and has left the factory in a condition that is safe for operation. The device complies with the applicable standards and regulations listed in the EU Declaration of Conformity and has CE marking on nameplate.

6. INSTALLATION AND CONNECTION

6.1. General recommendation

Run the signal line "twisted pair" or "twisted pair shielded" in case of high electromagnetic interference. Avoid running near power cables and large power consumers.

The equipment used with the transmitters should be resistant to electromagnetic interference from the transmission line in accordance with compatibility requirements.

6.2. Connection with PD connector

Loosen the screw at the top of the connector and the nut connecting the connector to the transmitter housing, the cable outlet can be set in any direction. It is advantageous to form the cable in the form of an eave loop in order to prevent the condensate from flowing towards the gland. Connect the wires according to the marking on the transmitter and table below (depending on the version). A correctly assembled PD connector should have the following tightened: the gland nut, the nut of the connector to the steel housing and the screw connecting both parts of the connector.

Table 2. Electrical connection of transmitter in current and voltage version

Voltage version		Current version	
Connector number	Connector type	Connector number	Connector type
1	+	1	+
2	VOLTAGE	2	-
3	-	3	Not supported
⏏	SHIELD OF CABLE	⏏	SHIELD OF CABLE

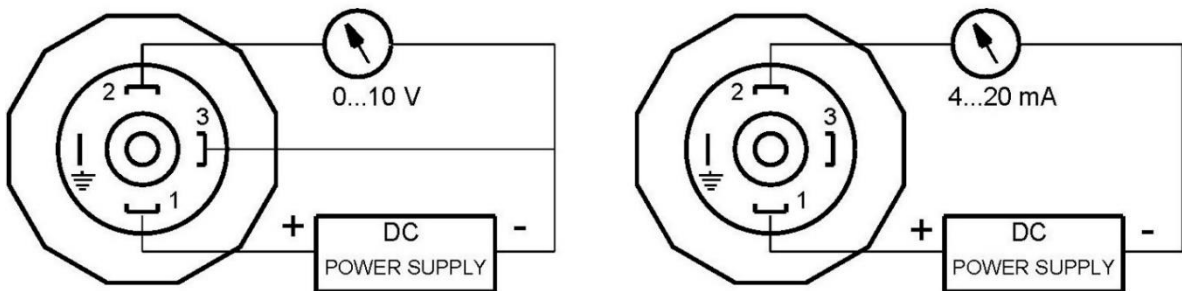

Figure 1. Transmitter connector diagram

6.3. Earthing

The PD connectors have a ground terminal that should not be used to realise protective earthing or to connect an equalising cable, it is only used for functional earthing.

7. POWER SUPPLY

Table 3. Transmitter supply voltage

8...36 V DC	Output signal 4...20 mA	2 wires
13...30 V DC	Output signal 0...10 V DC	3 wires

$$R_{Lmax} \geq 20 \text{ k}\Omega \quad \text{For voltage version} \quad R_{Lmax} = \frac{(U_{sup} - U_{min})}{0,02 \text{ A}} \quad \text{For current version}$$

where:

U_{sup} - voltage at the supply terminals of the 4...20 mA current loop [V].

U_{min} - minimum supply voltage of transmitter

R_{Lmax} - maximum power supply line resistance [Ω].

8. OPERATION

Protect the transmitter against mechanical damage and flooding.

Do not allow any sludge to form on the diaphragm. Carry out regular inspections.

Temperature range of measuring medium:

- -25 ÷ 120°C – direct measurement;
- > 120°C - measurement using a pulse tube, e.g. for media with a temperature of 160°C the length of the im-pulse tube should be at least 150 mm.

Isolation test voltage 110 V DC.

8.1. Setting of measurement range width and zero point

Unscrew the electrical connection to access the potentiometer knobs. Connect and power the transmitter according to the technical data. Apply a pressure equal to the lower limit of the measuring range and bring the output signal to 4 mA (0 V) by turning the "zero" potentiometer knob (turning it clockwise increases the output signal). After zeroing, set the pressure equal to the upper range limit and use the "range" potentiometer to bring the output current (voltage) to 20 mA (10 V). Check "zero" again and repeat the setting if necessary.



The user, by means of potentiometers, has the possibility to adjust the "zero" and the range within the limits up to $\pm 10\%$.
Transmitters with 0...10 V output signal manufactured up to the end of 2015 may not reach 0 V, in which case "zero" should be set to 0.05 V.

9. MAINTENANCE

9.1. Periodic inspections

Periodic inspections should be carried out in accordance with the standards binding for the user. During the inspection it is necessary to check the condition of pressure connections (absence of loosening and leakage) and electrical connections (checking the reliability of connections and the condition of seals and glands).

9.2. Cleaning, washing

In order to remove dirt from the external surfaces of the transmitter, wipe them with In order to remove dirt from the external surfaces of the transmitter, they should be wiped with a cloth dampened in water.

9.2.1. Diaphragm cleaning

The only possible method of cleaning the transmitter diaphragms is to dissolve the sludge produced.



Do not remove deposits and impurities from the transmitter diaphragms, which are formed during operation, mechanically using tools, since the diaphragms and the transmitter can be damaged.

9.3. Repair

Faulty or non-operational transmitter shall be provided to the manufacturer or an authorized representative.

9.4. Returns

In the following cases, the transmitter should be returned directly to the manufacturer:

- need for repair;
- need for factory calibration;
- replacement of improperly selected/shipped transmitter.

10. SCRAPPING, DISPOSAL



Worn or damaged devices shall be scrapped in accordance with WEEE Directive (2012/19/EU) on waste electrical and electronic equipment or returned to the manufacturer.

11. HISTORY OF REVISIONS

Revision No.	Document revision	Description of changes
-	Edition F/2017.11	First version of the document. Prepared by DKD.
1	01.A.001/2021.11	Initial document version. Prepared by DBFD.
2	01.A.002/2024.12	Corrected supply voltage. Editorial changes.

